

# FDD12 SERIES

DC - DC CONVERTER  
10 ~ 12W SINGLE & DUAL OUTPUT



## FEATURES

- LOW COST
- 4:1 WIDE INPUT RANGE
- I/O ISOLATION
- INPUT Pi FILTER
- SHORT CIRCUIT PROTECTION
- HIGH PERFORMANCE
- 2 YEARS WARRANTY

## MODEL LIST

MODEL NO.	INPUT VOLTAGE	INPUT CURRENT (typ.)	OUTPUT WATTAGE	OUTPUT VOLTAGE	OUTPUT CURRENT	EFF. (min.)	EFF. (typ.)	CAPACITOR LOAD (max.)
-----------	---------------	----------------------	----------------	----------------	----------------	-------------	-------------	-----------------------

### Single Output Models

FDD12 - 03S4	10~36 VDC	0.54 A	10 WATTS	+3.3 VDC	3000 mA	75%	78%	4700 $\mu$ F
FDD12 - 05S4	10~36 VDC	0.64 A	12 WATTS	+ 5 VDC	2400 mA	77%	80%	4700 $\mu$ F
FDD12 - 12S4	10~36 VDC	0.63 A	12 WATTS	+ 12 VDC	1000 mA	77%	80%	1000 $\mu$ F
FDD12 - 15S4	10~36 VDC	0.63 A	12 WATTS	+ 15 VDC	800 mA	77%	80%	470 $\mu$ F
FDD12 - 03S5	18~72 VDC	0.26 A	10 WATTS	+3.3 VDC	3000 mA	77%	80%	4700 $\mu$ F
FDD12 - 05S5	18~72 VDC	0.32 A	12 WATTS	+ 5 VDC	2400 mA	77%	80%	4700 $\mu$ F
FDD12 - 12S5	18~72 VDC	0.32 A	12 WATTS	+ 12 VDC	1000 mA	77%	80%	1000 $\mu$ F
FDD12 - 15S5	18~72 VDC	0.32 A	12 WATTS	+ 15 VDC	800 mA	77%	80%	470 $\mu$ F

### Dual Output Models

FDD12 - 05D4	10~36 VDC	0.64 A	12 WATTS	$\pm$ 5 VDC	$\pm$ 1200 mA	77%	80%	$\pm$ 2200 $\mu$ F
FDD12 - 12D4	10~36 VDC	0.64 A	12 WATTS	$\pm$ 12 VDC	$\pm$ 500 mA	77%	80%	$\pm$ 470 $\mu$ F
FDD12 - 15D4	10~36 VDC	0.64 A	12 WATTS	$\pm$ 15 VDC	$\pm$ 400 mA	77%	80%	$\pm$ 470 $\mu$ F
FDD12 - 05D5	18~72 VDC	0.32 A	12 WATTS	$\pm$ 5 VDC	$\pm$ 1200 mA	77%	80%	$\pm$ 2200 $\mu$ F
FDD12 - 12D5	18~72 VDC	0.32 A	12 WATTS	$\pm$ 12 VDC	$\pm$ 500 mA	77%	80%	$\pm$ 470 $\mu$ F
FDD12 - 15D5	18~72 VDC	0.32 A	12 WATTS	$\pm$ 15 VDC	$\pm$ 400 mA	77%	80%	$\pm$ 470 $\mu$ F

### SPECIFICATION

All Specifications Typical At Nominal Line, Full Load, 25°C Unless Otherwise Noticed

GENERAL					
Characteristics	Conditions	min.	typ.	max.	unit
Switching frequency	Vi nom, Io nom		200		KHz
Isolation voltage	Input - Output	1500			VDC
Isolation resistance	Input - Output, @ 500VDC	100			MΩ
Isolation capacitance	100KHz / 1V			1000	PF
Ambient temperature	Operating at Vi nom, Io nom	-25		+ 71	°C
Case temperature	Operating at Vi nom, Io nom			+ 100	°C
Derating	Vi nom	See derating curve			
Storage temperature	Non operational	-40		+ 100	°C
Relative humidity	Vi nom, Io nom	20		95	% RH
Temperature coefficient	Vi nom, Io min			± 0.02	% / °C
Dimension		L50.8 x W50.8 x H12.0			mm
MTBF	Belcore issue 6@40°C, GB		1040000		Hours
Cooling	Free air convection				

INPUT SPECIFICATIONS					
Characteristics	Conditions	min.	typ.	max.	unit
Input voltage range	Ta min ... Ta max, Io nom	10	24	36	VDC
		18	48	72	VDC
No load input current	Vi nom, Io = 0	24V models		20	mA
		48V models		15	mA
Input voltage w/o damage	Io nom	24V models		40	VDC
		48V models		75	VDC
Startup voltage	Io nom	24V models	9		VDC
		48V models		15	VDC
Input filter	Pi type				

OUTPUT SPECIFICATIONS					
Characteristics	Conditions	min.	typ.	max.	unit
Output voltage accuracy	Vi nom, Io nom			± 2	%
Minimum load	Vi nom	0			%
	single output models dual output models (each output)	20			%
Line regulation	Io nom, Vi min ... Vi max			± 1	%
Load regulation	Vi nom, Io 0 ... Io nom, single output models			± 2	%
	Vi nom, Io min ... Io nom, dual output models			± 5	%
Cross regulation (Dual model)	Aymmetrical load 20% - 100% FL			± 5	%
Startup time	Vi nom, Io nom			30	ms
Transient recovery time	Vi nom, I ~ 0.5 Io nom			500	μs
Ripple & noise	Vi nom, Io nom, BW = 20MHz	3.3V model		100	mV
		5V, 12V, 15V & dual		Vout x ± 1%	mV
Efficiency	Vi nom, Io nom, Po / Pi	Up to 80%, See model list and efficiency curve			

CONTROL AND PROTECTION	
Input reversed	Shunt diode built in, external fuse recommended ( 24Vin : 1.5A, 48Vin : 1A)
Output short circuit	Current limited (Auto-recovery)
Rated over load protection	110%min....140%max

### PHYSICAL CHARACTERISTICS

Case size	50.8 x 50.8 x 12.0 mm (2 x 2 x 0.47 inches)
Case material	Plastic base / Metal case
Weight	70 g
Patting material	Epoxy

### MECHANISM & PIN CONFIGURATION

mm [inch]

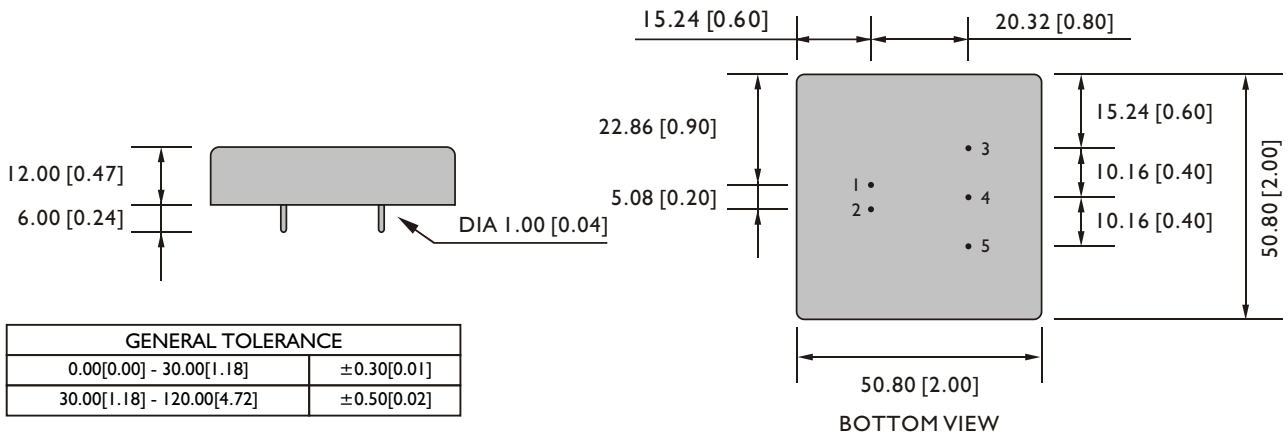

### PIN ASSIGNMENT

#### GENERAL

PIN NO.	1	2	3	4	5
SINGLE	Vi+	Vi-	Vo+	NO PIN	Vo-
DUAL	Vi+	Vi-	Vo+	com	Vo-

### CIRCUIT SCHEMATIC

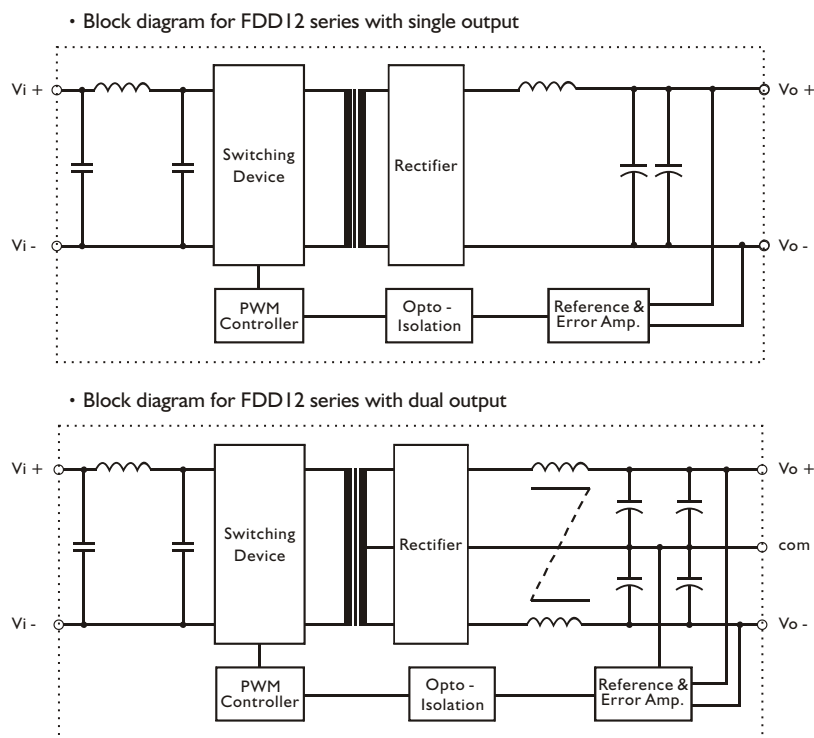

### RECOMMENDED CIRCUIT

- Recommended filter for EN55022 Class B compliance

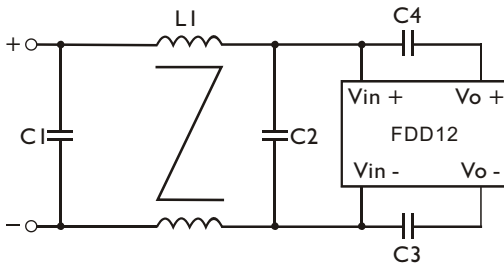

- The components used in the above figure, together with the manufacturer part numbers for these components, are as follows.

	C1	C2	C3	C4	L1
FDD12-XXX4	4.7 $\mu$ F / 50V MLCC	4.7 $\mu$ F / 50V MLCC	1nF / 2KV MLCC	1nF / 2KV MLCC	0.5mH Common Choke
FDD12-XXX5	6.8 $\mu$ F / 100V MLCC	6.8 $\mu$ F / 100V MLCC	1nF / 2KV MLCC	1nF / 2KV MLCC	0.5mH Common Choke

- Recommended EN 55022 Class B filter circuit layout.

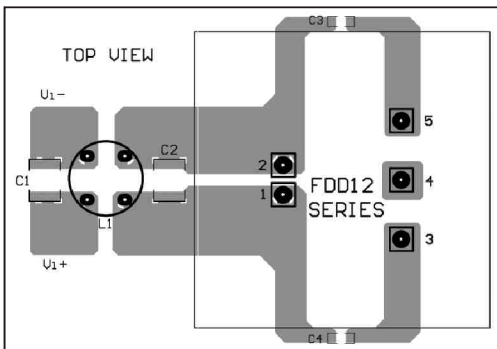

### DERATING AND EFFICIENCY CURVE

Temperature derating curve

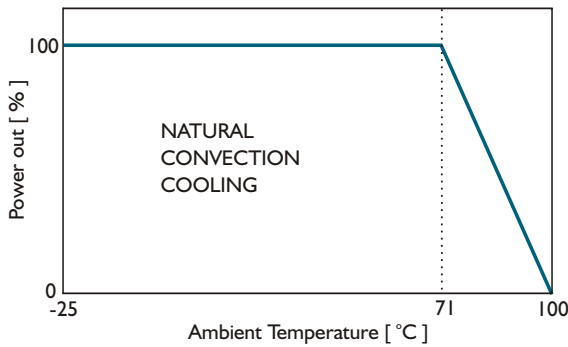

Efficiency Vs Input Voltage  
FDD12-05S4

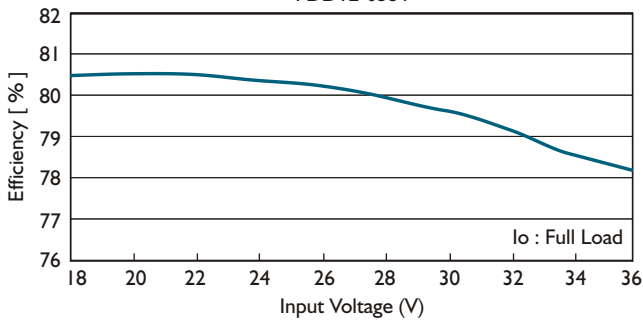

Efficiency Vs Output Load  
FDD12-05S4

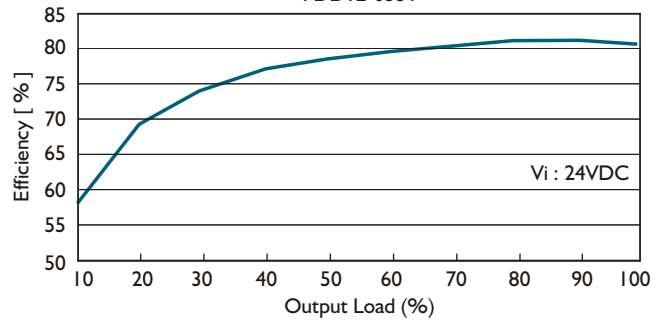

# FDD 12 SERIES

DC - DC CONVERTER  
12W TRIPLE OUTPUT



## FEATURES

- LOW COST
- 4:1 WIDE INPUT RANGE
- I/O ISOLATION
- LC INPUT FILTER
- SHORT CIRCUIT PROTECTION
- HIGH PERFORMANCE
- 2 YEARS WARRANTY

## MODEL LIST

MODEL NO.	INPUT VOLTAGE	INPUT CURRENT (typ.)	OUTPUT WATTAGE	OUTPUT VOLTAGE	OUTPUT CURRENT	EFF. (min.)	EFF. (typ.)	CAPACITOR LOAD (max.)
<b>Triple Output Models</b>								
FDD12 - 0512T4	10~36 VDC	0.62 A	12 WATTS	+5 / ±12 VDC	1.5A / ± 0.2 A	80%	82%	3500 $\mu$ F / ±1000 $\mu$ F
FDD12 - 0515T4	10~36 VDC	0.64 A	12 WATTS	+5 / ±15 VDC	1.5A / ± 0.16A	80%	82%	3500 $\mu$ F / ±1000 $\mu$ F
FDD12 - 0512T5	18~72 VDC	0.31 A	12 WATTS	+5 / ±12 VDC	1.5A / ± 0.2 A	80%	82%	3500 $\mu$ F / ±1000 $\mu$ F
FDD12 - 0515T5	18~72 VDC	0.31 A	12 WATTS	+5 / ±15 VDC	1.5A / ± 0.16A	80%	82%	3500 $\mu$ F / ±1000 $\mu$ F

### SPECIFICATION

All Specifications Typical At Nominal Line, Full Load, 25°C Unless Otherwise Noticed

#### GENERAL

Characteristics	Conditions	min.	typ.	max.	unit
Switching frequency	Vi nom, Io nom		200		KHz
Isolation voltage	Input - Output	1500			VDC
Isolation resistance	Input - Output, @ 500VDC	100			MΩ
Isolation capacitance	100KHz / 1V			1000	PF
Ambient temperature	Operating at Vi nom, Io nom	-25		+ 71	°C
Case temperature	Operating at Vi nom, Io nom			+ 100	°C
Derating	Vi nom	See derating curve			
Storage temperature	Non operational	-40		+ 100	°C
Relative humidity	Vi nom, Io nom	20		95	% RH
Temperature coefficient	Vi nom, Io min			± 0.02	% / °C
Dimension		L50.8 x W50.8 x H12.0			mm
MTBF	Belcore issue 6@40°C, GB		960000		Hours
Cooling	Free air convection				

#### INPUT SPECIFICATIONS

Characteristics	Conditions	min.	typ.	max.	unit
Input voltage range	Ta min ... Ta max, Io nom	10	24	36	VDC
		18	48	72	VDC
No load input current	Vi nom, Io = 0	24V models		25	mA
		48V models		15	mA
Input voltage w/o damage	Io nom	24V models		40	VDC
		48V models		75	VDC
Startup voltage	Io nom	24V models	9.4		VDC
		48V models	15		VDC
Input filter	Pi type				

#### OUTPUT SPECIFICATIONS

Characteristics	Conditions	min.	typ.	max.	unit
Output voltage accuracy	Vi nom, Io nom	+ 5V		± 2	%
		± 12V or ± 15V		± 6	%
Minimum load	Vi nom	+ 5V	10		%
		± 12V or ± 15V	20		%
Line regulation	Io nom, Vi min ... Vi max			± 2	%
Load regulation	Vi nom, Io min...Io nom	+ 5V		± 2	%
		± 12V or ± 15V		± 6	%
Cross regulation	Aymmetrical load 20% - 100% FL			± 6	%
Startup time	Vi nom, Io nom			30	ms
Transient recovery time	Vi nom, I ~ 0.5 Io nom			500	μs
Ripple & noise	Vi nom, Io nom, BW = 20MHz			Vout x ± 1%	mV
Efficiency	Vi nom, Io nom, Po / Pi	Up to 82%, See model list and efficiency curve			

#### CONTROL AND PROTECTION

Remote ON / OFF	ON : opened or 8 ~ 10VDC applied, reference to input GND OFF : -0.3 ~ 2VDC applied, reference to input GND
Input reversed	Shunt diode built in, external fuse recommended (24Vin : 1.5A, 48Vin : 1A)
Output short circuit	Current limited (Auto-recovery)
Rated over load protection	110%min....140%max

### PHYSICAL CHARACTERISTICS

Case size	50.8 x 50.8 x 12.0 mm (2 x 2 x 0.47 inches)
Case material	Plastic base / Metal case
Weight	70 g
Patting material	Epoxy

### MECHANISM & PIN CONFIGURATION

mm [inch]

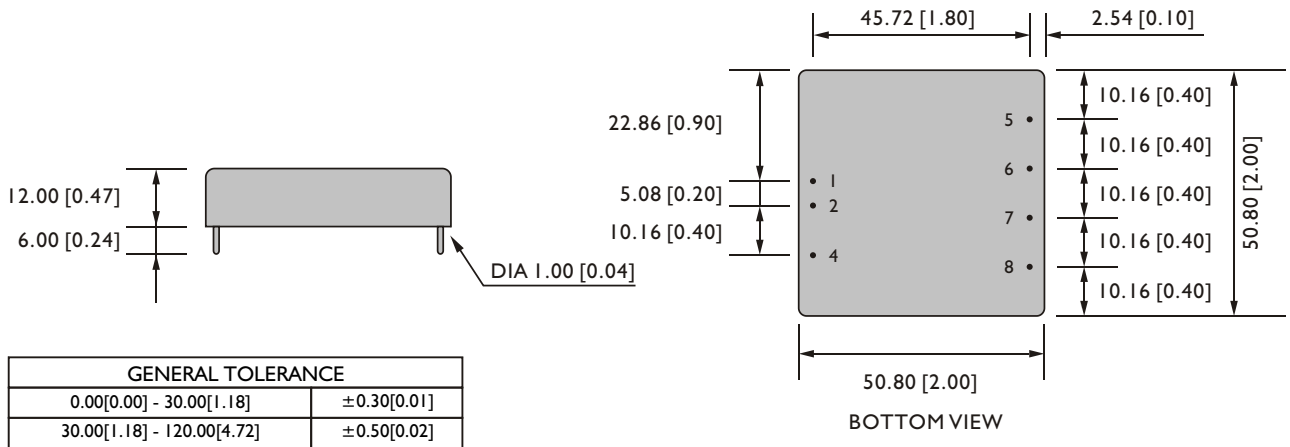

### PIN ASSIGNMENT

#### GENERAL

PIN NO.	1	2	4	5	6	7	8
TRIPLE	Vi+	Vi-	ON / OFF	Vo2 (+ OUT)	Vo1 (+ 5V)	com	Vo3 (- OUT)

### CIRCUIT SCHEMATIC

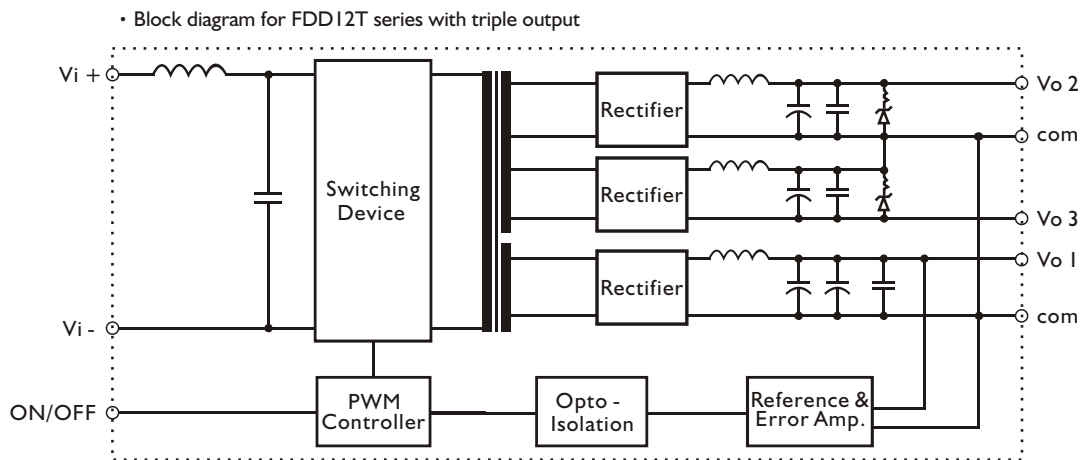

### RECOMMENDED CIRCUIT

- Recommended filter for EN55022 Class B compliance

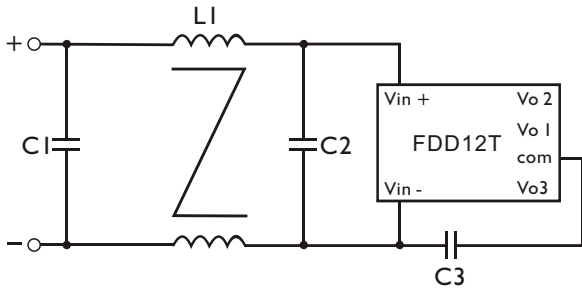

- The components used in the above figure, together with the manufacturer part numbers for these components, are as follows.

	C1	C2	C3	L1
FDD12-XXXXT4	3.3 $\mu$ F / 50V MLCC	3.3 $\mu$ F / 50V MLCC	1nF / 2KV MLCC	0.5mH Common Choke
FDD12-XXXXT5	3.3 $\mu$ F / 100V MLCC	3.3 $\mu$ F / 100V MLCC	1nF / 2KV MLCC	0.5mH Common Choke

- Recommended EN 55022 Class B filter circuit layout.

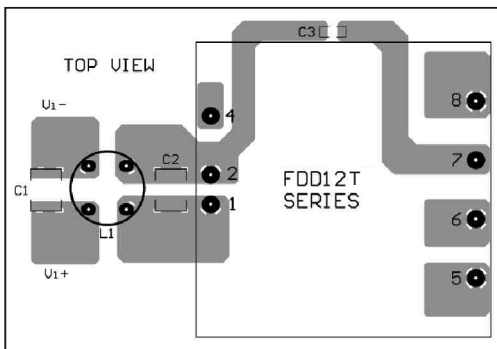

### DERATING AND EFFICIENCY CURVE

Temperature derating curve

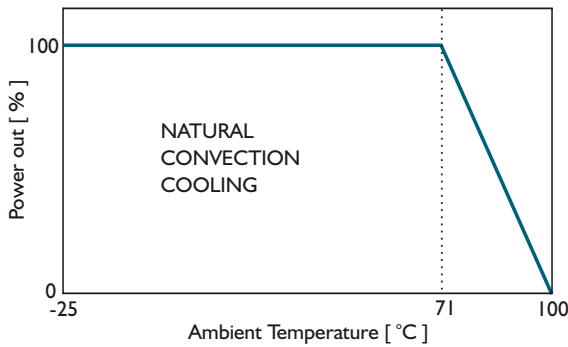

Efficiency Vs Input Voltage  
FDD12-0515T4

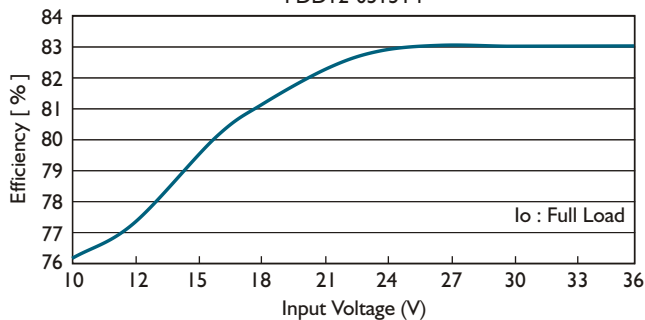

Efficiency Vs Output Load  
FDD12-0515T4

